

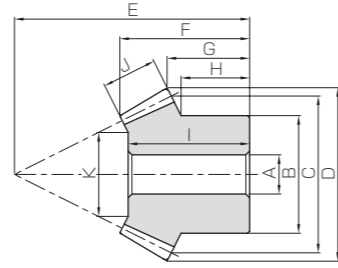

Specifications	
Precision grade	JIS B 1704: 1978 grade 4
Gear teeth	Gleason
Pressure angle	20°
Helix angle	35°
Material	S45C
Heat treatment	Teeth induction hardened
Tooth hardness	50 ~ 60HRC
Surface treatment	Black oxide coating

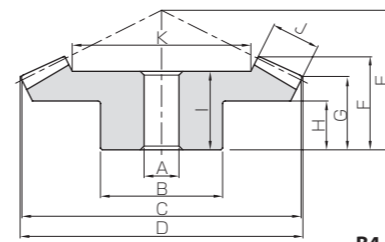

B3



B4

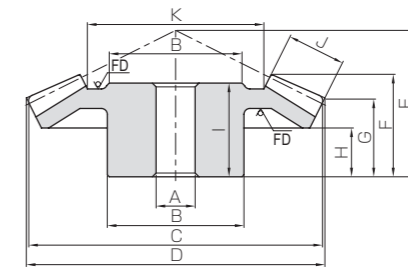

B5

* FD has die-forged finish.

Catalog No.	Gear ratio	Module	No. of teeth	Direction of spiral	Shape	Bore		Pitch dia.	Outside dia.	Mounting distance	Total length	Crown to back length	
						A	B					F	G
KSBS2-3020R KSBS2-2030L	1.5	m2	30	R	B4	12	35	60	61.36	40	26.8	12.02	
KSBS2.5-3020R KSBS2.5-2030L			20	L	B3	10	30	40	43.49	45	24.96	16.16	
KSBS3-3020R KSBS3-2030L		m3	30	R	B4	16	50	90	92.21	55	35.34	26.66	
KSBS4-3020R KSBS4-2030L			20	L	B3	16	45	60	65.58	70	40.17	26.86	
KSBS5-3020R KSBS5-2030L		m5	30	R	B4	25	90	150	153.67	90	58.08	42.75	
KSBS1-4020R KSBS1-2040L			m1	40	R	B4	8	25	40	40.52	22	15.02	12.52
KSBS1.5-4020R KSBS1.5-2040L		20		L	B3	6	16	20	22.08	28	13.73	8.52	
KSBS2-4020R KSBS2-2040L		m2	40	R	B4	12	40	80	81	45	32.27	26	
KSBS2.5-4020R KSBS2.5-2040L			20	L	B3	12	32	40	44.1	60	34.04	21.02	
KSBS3-4020R KSBS3-2040L		m3	40	R	B4	20	60	120	121.48	65	45.76	36.47	
KSBS4-4020R KSBS4-2040L	20		L	B3	16	50	60	66.07	90	50.63	31.52		
KSBS5-4020R KSBS5-2040L	m5	40	R	B4	25	100	200	202.54	90	55.02	42.54		
KSBS2.5-3618R KSBS2.5-1836L		m2.5	36	R	B4	15	55	90	91.29	43	28.38	21.79	
KSBS3-3618R KSBS3-1836L	m3		18	L	B3	12	38	45	50.30	64	34.06	20.32	
KSBS4-3618R KSBS4-1836L		36	R	B4	20	60	108	109.53	52	34.82	26.53		
KSBS2-4518R KSBS2-1845L	m2	45	R	B4	12	48	90	90.79	40	27.67	22.98		
KSBS2.5-4518R KSBS2.5-1845L		m2.5	18	L	B3	10	32	36	40.42	60	28.54	15.88	
KSBS3-4518R KSBS3-1845L	m3		45	R	B4	15	55	112.5	113.49	50	34.94	28.74	
KSBS4-4518R KSBS4-1845L		18	L	B3	12	40	45	50.35	72	33.19	16.82		
KSBS5-4518R KSBS5-1845L	m5	45	R	B4	25	80	180	181.57	75	50.98	40.96		
KSBS2-2030L KSBS2-3020R		m2	18	L	B3	16	48	54	60.69	85	37.82	18.84	
KSBS2.5-2030L KSBS2.5-3020R	m2.5		45	R	B4	25	80	180	181.57	75	50.98	40.96	
KSBS3-2030L KSBS3-3020R		m3	18	L	B3	16	48	54	60.69	85	37.82	18.84	
KSBS4-2030L KSBS4-3020R	m4		45	R	B4	25	80	180	181.57	75	50.98	40.96	
KSBS5-2030L KSBS5-3020R		18	L	B3	20	62	72	80.86	110	48.03	21.77		
KSBS1-2040L KSBS1-4020R	m1	45	R	B4	30	100	225	225.81	90	57.9	46.01		
KSBS1.5-2040L KSBS1.5-4020R		m1.5	18	L	B3	22	80	90	103.87	135	56.02	25.27	

- [Caution on Product Characteristics]
- ① The allowable torques shown in the table are the calculated values according to the assumed usage conditions. Please see page 303 for more details.
 - ② Dimensions of the outside diameter, the overall length and crown to back length are all theoretical values, and some differences will occur due to the corner chamfering of the gear tips.
 - ③ These gears produce axial thrust forces. See Page 304 for more details.
 - ④ Due to heat treating, some deformation of the bore may occur. It may be necessary to ream the bore to bring it to the stated dimensions.

Hub width	Length of bore	Face width	Holding surface dia.	Allowable torque (N·m)		Allowable torque (kgf·m)		Backlash (mm)	Weight (kg)	Catalog No.
				Bending strength	Surface durability	Bending strength	Surface durability			
H	I	J	K							
15	23		37.56	15.4	11.3	1.57	1.15	0.06~0.16	0.26	KSBS2-3020R
11.67	22	11	21.34	10.5	7.52	1.07	0.77			
18	30		45.61	31.7	23.6	3.23	2.40	0.07~0.17	0.55	KSBS2.5-3020R
14.17	28	15	27.42	21.6	15.7	2.20	1.60			
17	31		57.14	52.9	39.7	5.39	4.05	0.08~0.18	0.82	KSBS3-3020R
20	37	17	34.71	36.1	26.5	3.68	2.70			
25	40		78.59	115	88.1	11.8	8.99	0.12~0.27	1.90	KSBS4-3020R
23.33	43	20	46.89	78.7	58.8	8.03	5.99			
24	50		91.22	253	195	25.8	19.9	0.14~0.34	4.11	KSBS5-3020R
28.33	56	30	54.83	173	130	17.6	13.3			
8	12		26.58	3.01	2.22	0.31	0.23	0.03~0.13	0.068	KSBS1-4020R
7	12	6	9.17	1.51	1.11	0.15	0.11			
15	22		39.64	10.9	8.22	1.11	0.84	0.05~0.15	0.27	KSBS1.5-4020R
14.75	24	10	17.28	5.46	4.11	0.56	0.42			
18	27		48.46	27.8	21.3	2.83	2.17	0.06~0.16	0.51	KSBS2-4020R
18	32	15	20.92	13.9	10.7	1.42	1.09			
20	34		59.28	56.4	43.7	5.75	4.46	0.07~0.17	1.06	KSBS2.5-4020R
22.5	40	20	20.56	28.2	21.9	2.88	2.23			
24	38		73.81	92.5	72.6	9.44	7.40	0.08~0.18	1.67	KSBS3-4020R
27.5	47	22	29.61	46.4	36.3	4.73	3.70			
28	45		102.39	213	170	21.7	17.3	0.12~0.27	3.33	KSBS4-4020R
35	62	28	42.78	107	84.8	10.9	8.65			
26	50		138.92	376	302	38.3	30.8	0.14~0.34	5.67	KSBS5-4020R
35	63	30	57.84	188	151	19.2	15.4			
13	24		57.72	41.7	29.3	4.26	2.99	0.07~0.17	0.72	KSBS2.5-3618R
17.25	32	16	25.45	20.9	14.7	2.13	1.49			
17	30		68.27	74.0	52.4	7.54	5.35	0.08~0.18	1.15	KSBS3-3618R
19	37	20	28.56	37.0	26.2	3.78	2.67			
25	42		91.87	173	124	17.6	12.7	0.12~0.27	2.65	KSBS4-3618R
25	49	26	39.72	86.4	62.1	8.81	6.33			
15	25		62.24	31.0	21.9	3.16	2.23	0.06~0.16	0.65	KSBS2-4518R
14.2	27.5	14	23.11	12.2	8.74	1.24	0.89			
18	31		76.53	61.6	44.0	6.28	4.49	0.07~0.17	1.23	KSBS2.5-4518R
14.75	31.5	18	26.82	24.2	17.6	2.47	1.80			
22	37		92.96	104	75.4	10.7	7.69	0.08~0.18	2.05	KSBS3-4518R
16.3	36	21	33.41	41.0	30.2	4.18	3.07			
24	45		122.33	253	185	25.8	18.9	0.12~0.27	4.62	KSBS4-4518R
18	46	29	45.83	99.5	74.1	10.2	7.56			
28	51		156.56	474	350	48.4	35.7	0.14~0.34	8.11	KSBS5-4518R
20.5	52.5	34	56.9	186	140	19.0	14.3			

- [Caution on Secondary Operations]
- ① Please read "Caution on Performing Secondary Operations" (Page 304) when performing modification and/or secondary operations for safety concerns.
 - ② Due to the gear teeth being induction hardened, no secondary operations can be performed on tooth areas including the bottom land (approx. 2 to 3 mm).

Characteristics



KHK stock bevel gears are available in two types, spiral and straight tooth, in gear ratios of 1.5 through 5, and are offered in a large variety of modules, numbers of teeth, materials and styles. The following table lists the main features for easy selection.

Type	Catalog No.	Module	Gear Ratio	Material	Heat Treatment	Tooth Surface Finish	Precision JIS B 1704 : 1978	Secondary Operations	Features
Spiral bevel gears	KMHP	1, 1.5	15~60	SCM415	Carburized Note 1	Cut	3	△	High speed reduction ratio, high efficiency, high rigidity and compact gear assembly.
	KMBSG	2~4	2	SCM415	Carburized Note 1	Ground	1	△	High strength, abrasion-resistant and compact for high-speed & torque use.
	KSBSG	2~4	1.5~3	S45C	Gear teeth induction hardened	Ground	2	△	Reasonably priced ground gear, yet remachinable except for the gear teeth.
	KKSP	1.5~5	1.5, 2	SCM415	Carburized Note 1	Ground	0	△	Superior performance with regard to high speed, low noise, and low vibration.
	KMBSA · KMBSB	2~6	1.5~3	SCM415	Carburized	Cut	4	×	Ready to use without performing secondary operations. Strong and abrasion resistant.
Zerol Bevel Gears	KSBS	1~5	1.5~4	S45C	Gear teeth induction hardened	Cut	4	△	Large nos. of teeth and modules are offered in these affordable spiral bevel gears.
	KSBZG	2~3	1.5~2	S45C	Gear teeth induction hardened	Ground	2	△	A spiral bevel gears with a helix angle less than 10°. Receives forces from the same directions straight bevel gears receive and have excellent precision.
Straight bevel gears	KSB · KSBY	1~8	1.5~5	S45C	—	Cut	3	○	Popular series of straight bevel gears for many uses.
	KSUB	1.5~3	1.5~3	SUS303	—	Cut	3	○	Suitable for food machinery due to SUS303's rust-resistant quality.
	KPB	1~3	1.5~3	MC901	—	Cut	4	○	MC nylon products are light and can be used without lubricant.
	KDB	0.5~1	2	Duracon (M90-44)	—	Injection Molded	6	△	Injection molded, mass-produced productions, suitable for office machines.

(NOTE 1) Although these are carburized products, secondary operations can be performed as the bore and the hub portions are masked during the carburization. However, as a precaution, high hardness (HRC40 at maximum) occurs in some cases.

○ Possible △ Partly possible
× Not possible

Application Examples



KHK stock bevel gears are used as gears for power transmission of intersecting axes in various devices.

Differential Gear Mechanism Example

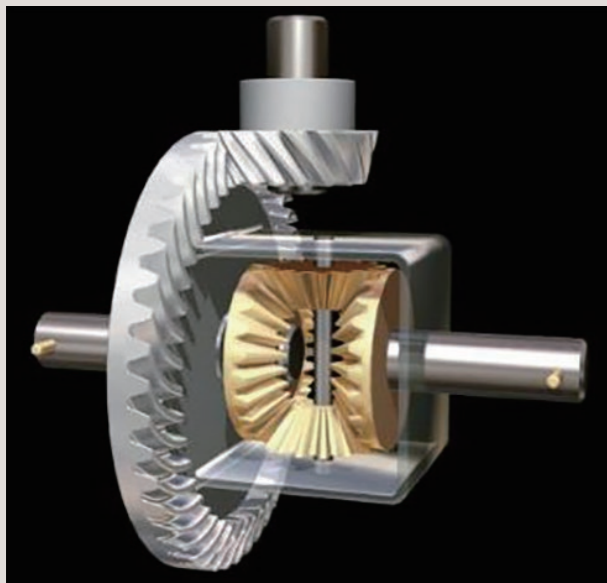
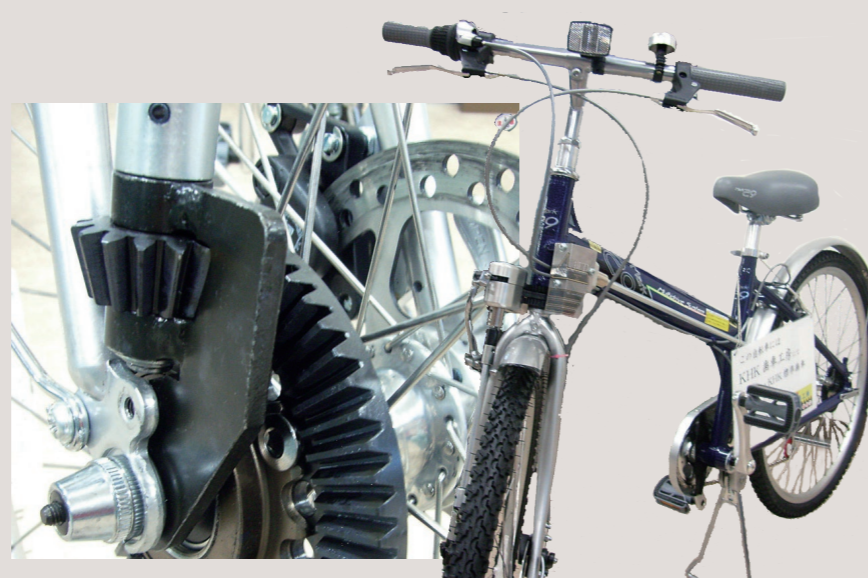

Image provided by: PK Design

SHESCO 2WD Bike



KSB Bevel Gears are used in the driving components in both the front and rear wheels

Selection Hints



Please select the most suitable products by carefully considering the characteristics of items and contents of the product tables. It is also important to read all applicable "CAUTION" notes shown below before the final selection.

1. Caution in Selecting the Mating Gears

Basically, KHK stock bevel gears should be selected as shown in the catalog in pairs (e.g. KMBSG2-4020R should mate with KMBSG2-2040L). But, for straight tooth bevel gears, there is some interchangeability with different series. For plastic bevel gears, we recommend metal mating gears for good heat conductivity.

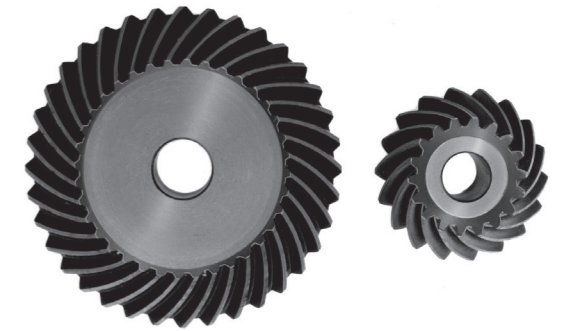

Right (R)

Left (L)

Selection Chart for Straight Bevel Gears (○ Allowable × Not allowable)

Gear	KSB	KSUB	KPB	KDB
Pinion	○	○	○	×
KSB	○	○	○	×
KSUB	○	○	○	×
KPB	○	○	○	×
KDB	×	×	×	○

Zerol Bevel Gears

KSBZG products are not interchangeable with products in other series.

2. Caution in Selecting Gears Based on Gear Strength

The gear strength values shown in the product pages were computed by assuming a certain application environment. Therefore, they should be used as reference only. We recommend that each user computes their own values by applying the actual usage conditions. To learn more about strength calculation, please refer to the technical information contained in the "Bending Strength of Bevel Gears" section on Page 87, and the "Surface Durability of Bevel Gears" section on Page 92.

Calculation assumptions for Bending Strength of Gears

Item	Catalog No.	KMBSG KMBSA KMBSB	KSBSG KSBZG KSBS	KSB NOTE 3 KSBY	KSUB	KPB	KDB
Formula NOTE 1	Formula of bevel gears on bending strength(JGMA403-01)				The Lewis formula		
No. of teeth of mating gear	No. of teeth of the mating gear of the set				—		
Rotational Speed	100rpm (600rpm for KMBSG, KSBSG and KSBZG)				100rpm		
Design Life (Durability)	Over 10 ⁷ cycles				—		
Impact from motor	Uniform load				Allowable bending stress (kgf/mm ²)		
Impact from load	Uniform load				1.15		
Direction of load	Bidirectional				(40°C with No Lubrication)		
Allowable bending stress at root σ_{Fim} (kgf/mm ²) NOTE 2	47	21	19 (24.5)	10.5	m 0.5 4.0 m 0.8 4.0 m 1.0 3.5 (40°C with Grease Lubrication)		
Safety factor K_R	1.2						

Calculation assumptions for Surface Durability (Except those in common with bending strength)

Item	Catalog No.	KMBSG KMBSA KMBSB	KSBSG KSBZG KSBS	KSB NOTE 3 KSBY	KSUB	KPB	KDB
Formula NOTE 1	Formula of bevel gears on surface durability (JGMA404-01)						
Kinematic viscosity of lubricant	100cSt (50°C)						
Gear support	Shafts & gear box have normal stiffness, and gears are supported on one end						
Allowable Hertz stress σ_{Hlim} (kgf/mm ²)	166	90	49 (62.5)	41.3			
Safety factor C_R	1.15						

(NOTE 1) The gear strength formula is based on JGMA (Japanese Gear Manufacturers Association) specifications. "MC Nylon Technical Data" by Nippon Polyplastic Limited and "Duracon Gear Data" by Polyplastic Co. Also, the units (rpm) of number of rotations and unit (kgf/mm²) of stress are adjusted to the units needed in the formula.

(NOTE 2) The allowable bending stress at the root σ_{Fim} is calculated from JGMA403-01, and set to 2/3 of the value in the consideration of the use of planetary-, idler-, or other gear systems, loaded in both directions.

(NOTE 3) Since KSB Bevel Pinion Shafts are thermally refined, the allowable tooth-root bending stress and allowable hertz stress are the value shown in parentheses.

Application Hints

In order to use KHK stock gears safely, carefully read the Application Hints before proceeding. If there are questions or you require clarifications, please contact our technical department or your nearest distributor.

TEL: 1-516-437-6700 FAX: 1-516-328-3343 E-mail: qtcsupport@qtcgears.com

1. Cautions on Handling

- ① KHK products are packaged one by one to prevent scratches and dents, but if you find issues such as rust, scratches, or dents when the product is removed from the box after purchase, please contact the supplier.
- ② Depending on the handling method, the product may become deformed or damaged. Resin gears and ring gears deform particularly easily, so please handle with care.

2. Caution on Performing Secondary Operations

- ① If you are re-boring, it is important to pay special attention to locating the center in order to avoid runout.
- ② The reference datum for gear cutting is the bore. Therefore, it is best to use the bore for locating the center. If it is too difficult to do for small bores, the alternative is to use one spot on the bore and the runout of the side surface.
- ③ If reworking using scroll chucks, we recommend the use of new or rebored jaws for improved precision. Please exercise caution not to crush the teeth by applying too much pressure. Any scarring will cause noise during operation.

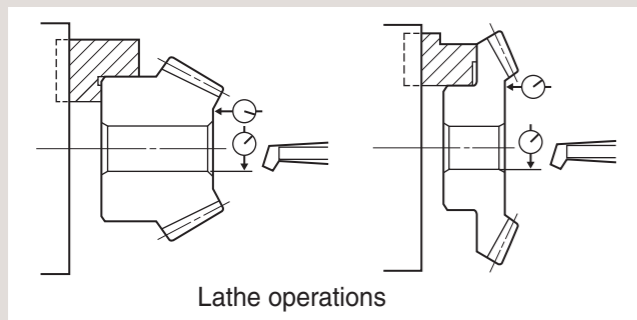

- ④ For items with induction hardened teeth, such as KSBG and KSB series, the hardness is high near the tooth root. When machining the front end, the machined area should be 4 to 6mm smaller than the dimension, J.

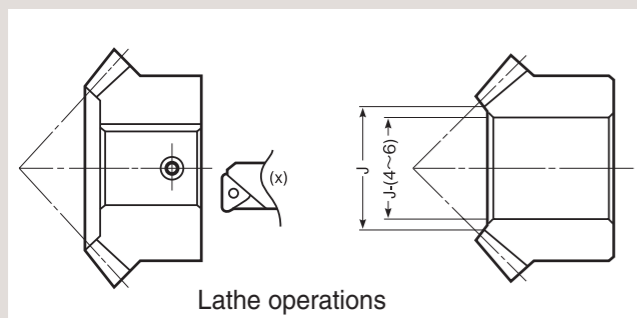

- ⑤ For tapping and keyway operations, see the examples given in "1. Caution on Performing Secondary Operations" in KHK Stock Spur Gear section. When cutting keyways, to avoid stress concentrations, always leave radii on corners.
- ⑥ KPB plastic bevel gears are susceptible to changes due to temperature and humidity. Dimensions may change between, during, and after re-machining operations.

- ⑦ When heat treating S45C products, it is possible to get thermal stress cracks. It is best to subject them to penetrant inspection afterwards. While the teeth strength may increase four fold, the precision of the gear will drop approximately one grade.
- ⑧ For the handling conveniences, the KSB and KSBY series listed below have the tapped holes (180° apart, 2 places) on the holding surface.

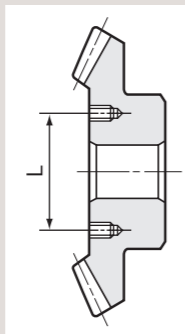

Catalog No.	L (mm)	Tap Size
KSB6-4515	130	M10 deep 20
KSBY8-4020	160	M10 deep 20
KSBY8-4515	210	M10 deep 20
KSBY5-6015	160	M10 deep 20
KSBY6-6015	220	M10 deep 20

3. Points of Caution in Assembling

- ① Since bevel gears are cone shaped, they produce axial thrust forces. Especially for spiral bevel gears, the directions of thrust changes with the hand of spiral and the direction of rotation. This is illustrated below. The bearings must be selected properly to be able to handle these thrust forces. For details, please refer to separate technical reference book, section of "Gear Forces" (Page 107).

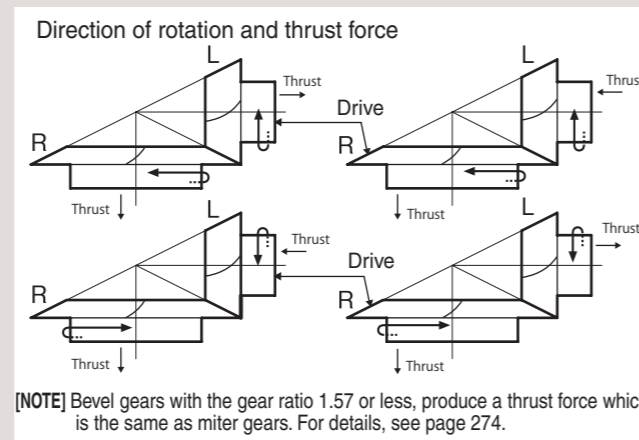

- ② If a bevel gear is mounted on a shaft far from the bearings, the shaft may bend. We recommend mounting bevel gears as close to the bearings as possible. This is especially important since most bevel gears are supported on one end. The bending of shafts will cause abnormal noise and wear, and may even cause fatigue failure of the shafts. Both shafts and bearings must be designed with sufficient strength.
- ③ Due to the thrust load of bevel gears, the gears, shafts and bearings have the tendency to loosen up during operation. Bevel gears should be fastened to the shaft with keys and set screws, taper pins, step shafts, etc.

- ④ When installing KMBSA or KMBSB spiral bevel gears produced in B7 style (ring type), always secure the gears onto the mounting base with taper pins to absorb the rotational loads. It is dangerous to secure with bolts only.

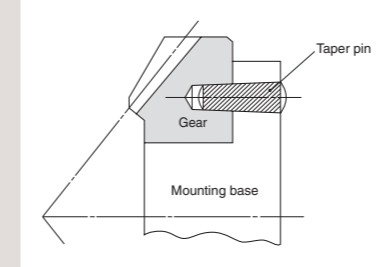

- ⑤ KHK stock bevel gears are designed such that, when assembled according to the specified mounting distance with a tolerance of H7 to H8, the normal direction backlash shown in the table is obtained. Mounting distance error, offset error and shaft angle error must be minimized to avoid excessive noise and wear. For various conditions of teeth contact, please see the following illustrations, "Correct Tooth Contact" and "Incorrect Tooth Contact".

Gear Ratio (Reduction Ratio)	Normal direction Backlash	Travel in axial direction	
		Pinions	Gears
1.5	j_n	$0.81 \times j_n$	$1.22 \times j_n$
2		$0.65 \times j_n$	$1.31 \times j_n$
2.5		$0.54 \times j_n$	$1.36 \times j_n$
3		$0.46 \times j_n$	$1.39 \times j_n$
4		$0.35 \times j_n$	$1.42 \times j_n$
5		$0.29 \times j_n$	$1.43 \times j_n$
15 or more		$1.4 \times j_n \div \text{Gear Ratio}$	$1.40 \times j_n$

4. Cautions on Starting

- ① Check the following items before starting.
 - Are the gears installed securely?
 - Is there uneven tooth contact?
 - Is there adequate backlash? Be sure to avoid zero-backlash.
 - Has proper lubrication been supplied?
- ② If gears are exposed, be sure to attach a safety cover to ensure safety. Also, be careful not to touch rotating gears.
- ③ Gears can be lubricated with the "grease lubrication method", "splash lubrication method (oil bath method)", or "forced lubrication method (circulation lubrication method)". For initial operation, the lubricant may deteriorate markedly, so check the condition of the lubricant after starting. For more technical information, please see the section "Gear Lubrication" (Page 112) of our technical reference book.
- ④ If there is any abnormality such as noise or vibration during startup, check the gears and assembly condition. "High gear accuracy", "smooth gear teeth surface" and "correct tooth contact" are some of the measures against gear noise. For more technical information, please see the section "Gear Noise and Countermeasures" (Page 119) of our technical reference book.

Correct Tooth Contact

- When assembled correctly, the contact will occur on both gears in the middle of the flank and center of face width but somewhat closer to the toe.

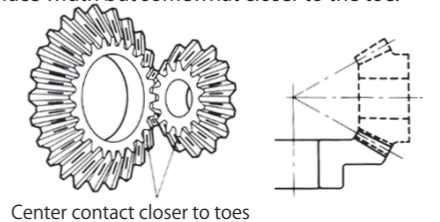

Incorrect Tooth Contact

■ Mounting Distance Error

- When the mounting distance of the pinion is incorrect, the contact will occur too high on the flank on one gear and too low on the other.

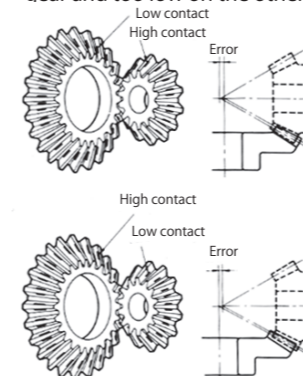

■ Offset Error

- When the pinion shaft is offset, the contact surface is near the toe of one gear and near the heel of the other.

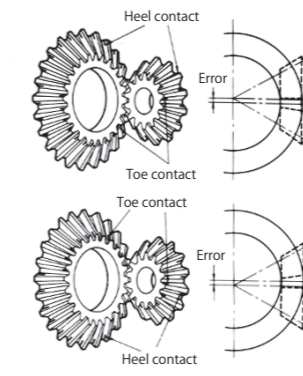

■ Shaft Angle Error

- When there is an angular error of shafts, the gears will contact at the toes or heels depending on whether the angle is greater or less than 90°.

