

SPRING-POWERED REELS



FOR POINT-OF-PURCHASE DISPLAYS
 COMPACT SIZE
 RETRACTABLE CABLE

PHONE: 516.328.3300 • FAX: 516.326.8827 • WWW.SDP-SI.COM



► **MATERIAL:**

- Case** - Nylon, Black or White
- Cable** - Stainless Steel, Nylon Coated
- Cable End Terminal** - Eyelet for #8 screw (.175 in.)
- Spring** - Stainless Steel

► **SPECIFICATION:**

Endurance: Min. Number of Cycles: 10,000

► **MODIFICATIONS:**

Other attachment plates, cable or end attachments are available on special request.

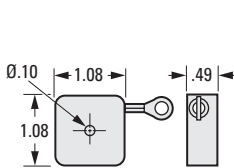

Fig. 1

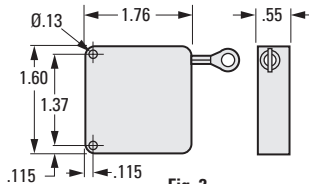

Fig. 2

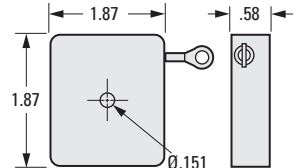

Fig. 3

INCH COMPONENT

Catalog Number	Case Color	Nominal Max. Deflection in.	Nominal Retracting Load ozf at Max. Extension	Cable Min. Breaking Strength lbf
Fig. 1 Cable - .018 in. Stainless Steel, Clear Nylon Coated to .024 in.				
A 3Z55-A04	Black	26	4	40
Fig. 2 Cable - .027 in. Stainless Steel, Black Nylon Coated to .034 in.				
A 3Z55-B03	Black	42	3	90
Fig. 3 Cable - .018 in. Stainless Steel, Clear Nylon Coated to .024 in.				
A 3Z55-C03	White	60	3	40
A 3Z55-C07	White	50	7	40
A 3Z55-C12	White	40	12	40

NEW

**CABLE END FITTING
SECURES PRODUCT
UNOBTRUSIVELY TO DISPLAY
SAVES ON ASSEMBLY COST
ONE-PIECE CONSTRUCTION**

PHONE: 516.328.3300 • FAX: 516.326.8827 • WWW.SDP-SI.COM



> MATERIAL:

ABS Plastic, Black

> MODIFICATIONS:

Other cable attachment methods available on special request include:

1. Plastic attachment plate with or without white adhesive tape.
2. Stainless Steel attachment plate with adhesive tape.
3. Two plastic attachment plates one stationary & one sliding.

INCH COMPONENT
Catalog Number
A 3Z55-CBLATT

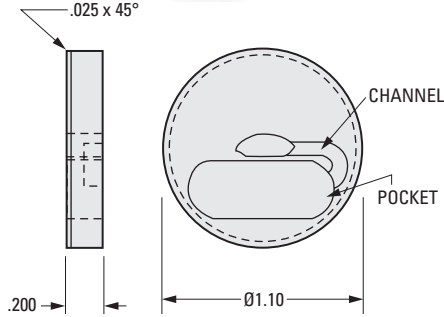

NOTE: Includes double-sided tape.

To Assemble:

1. Place ring terminal into slot.

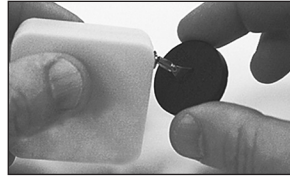

2. Holding the end of the terminal, guide cable through channel.

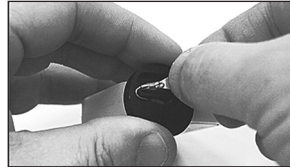

3. Depress terminal into "pocket".

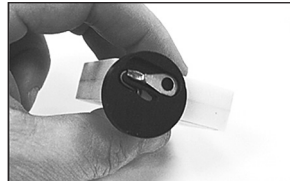

4. Attach double-sided tape.



I
R
T
1
2
3
4
5
6
7
8
9
10
11
12
13
14
NEW
16